

ERB5007A
ERB5004A
EFB4207A
EFB4204A

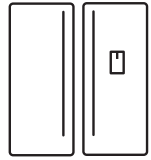

EN Refrigeration

User manual



Electrolux

CONTENTS

1. SAFETY INFORMATION	3
2. SAFETY INSTRUCTION	4
3. DESCRIPTION OF THE APPLIANCE	6
4. TEMPERATURE CONTROL	10
5. INSTALLING YOUR NEW REFRIGERATOR	14
6. USING YOUR REFRIGERATOR	15
7. CLEANING THE REFREIGERATOR FOOD	18
8. FOOD STORAGE GUIDE	19
9. TROUBLESHOOTING	20
10. NOISES	23

WE'RE THINKING OF YOU

Thank you for purchasing an Electrolux appliance. You've chosen a product that brings with it decades of professional experience and innovation. Ingenious and stylish, it has been designed with you in mind. So whenever you use it, you can be safe in the knowledge that you'll get great results every time.

Welcome to Electrolux.

Visit our website to:



Get usage advice, brochures, trouble shooter, service information:
www.electrolux.com



Register your product for better service:
www.electrolux.com/productregistration



Buy Accessories, Consumables and Original spare parts for your appliance: www.electrolux.com/shop

CUSTOMER CARE AND SERVICE

We recommend the use of original spare parts.
When contacting Service, ensure that you have the following data available. The information can be found on the rating plate. Model, PNC, Serial Number



Warning / Caution-Safety information.



General information and tips



Environmental information.

Subject to change without notice.

1. SAFETY INFORMATION

Before the installation and use of the appliance, carefully read the supplied instructions. The manufacturer is not responsible if an incorrect installation and use causes injuries and damages. Always keep the instructions with the appliance for future reference.

1.1 Children and vulnerable people safety

- This appliance can be used by children aged from 8 years and above and persons with reduced physical, sensory or mental capabilities or lack of experience and knowledge if they have been given supervision or instruction concerning use of the appliance in a safe way and understand the hazards involved.
- Do not let children play with the appliance.
- Keep all packaging away from children.
- Cleaning and user maintenance shall not be made by children without supervision.

1.2 General Safety

- This appliance is intended to be used in household and similar applications such as:
 - Farm houses; staff kitchen areas in shops, offices and other working environments
 - By clients in hotels, motels, bed and breakfast and other residential type environments
- Keep ventilation openings, in the appliance enclosure or in the built-in structure, clear of obstruction.
- Do not use mechanical devices or other means to accelerate the defrosting process, other than those recommended by the manufacturer.
- Do not damage the refrigerant circuit.
- Do not use electrical appliances inside the food storage compartments of the appliance, unless they are of the type recommended by the manufacturer.
- Do not use water spray and steam to clean the appliance.
- Clean the appliance with a moist soft cloth. Only use neutral detergents. Do not use abrasive products, abrasive cleaning pads, solvents or metal objects.
- Do not store explosive substances such as aerosol cans with a flammable propellant in this appliance.

- If the supply cord is damaged, it must be replaced by the manufacturer, its service agent or similarly qualified persons in order to avoid a hazard.
- If the appliance is equipped with an Ice maker or a water dispenser, fill them with potable water only.
- If the appliance requires a water connection, connect it to potable water supply only.
- The inlet water pressure (minimum and maximum) must be between 1 bar (0,1 MPa) and 10 bar (1 MPa)

2. SAFETY INSTRUCTIONS

2.1 Installation



WARNING!

Only a qualified person must install this appliance.

- Remove all the packaging.
- Do not install or use a damaged appliance.
- Obey the installation instruction supplied with the appliance.
- Always be careful when you move the appliance because it is heavy. Always wear safety gloves.
- Make sure the air can circulate around the appliance.
- Wait at least 4 hours before connecting the appliance to the power supply. This is to allow the oil to flow back in the compressor.
- Do not install the appliance close to radiators or cookers, oven or hobs.
- The rear of the appliance must stand against the wall.
- Do not install the appliance where there is direct sunlight.
- Do not install this appliance in areas that are too humid or too colds, such as the construction appendices, garages or wine cellars.
- When you move the appliance, lift it by the front edge to avoid scratching the floor.

2.2 Electrical connection



WARNING!

Risk of fire and electrical shock.

- The appliance must be earthed.
- All electrical connections should be made by a qualified electrician.
- Make sure that the electrical information on the rating plate agrees with the power supply. If not, contact an electrician.
- Always use a correctly installed shockproof socket.
- Do not use multi-plug adapters and extension cables.
- Make sure not to cause damage to the electrical components (e.g. mains plug, mains cable, compressor). Contact the Service or an electrician to change the electrical components.
- The mains cable must stay below the level of the mains plug.
- Connect the mains plug to the mains socket only at the end of the installation. Make sure that there is access to the mains plug after the installation.
- Do not pull the mains cable to disconnect the appliance. Always pull the mains plug.

2.3 Use



WARNING!

Risk of injury, burns, electrical shock or fire.

- Do not change the specification of this appliance.
- Do not put electrical appliances (e.g. ice cream makers) in the appliance unless they are stated applicable by the manufacturer.
- Be careful not to cause damage to the refrigerant circuit. It contains isobutane (R600a), a natural gas with a high level of environmental compatibility. This gas is flammable.
- If damage occurs to the refrigerant circuit, make sure that there are no flames and sources of ignition in the room. Ventilate the room.
- Do not let hot items to touch the plastic parts of the appliance.
- Do not put soft drinks in the freezer compartment. This will create pressure on the drink container.
- Do not store flammable gas and liquid in the appliance.
- Do not put flammable products or items that are wet with flammable products in, near or on the appliance.
- Do not touch the compressor or the condenser. They are hot.
- Do not remove or touch items from the freezer compartment if your hands are wet or damp.
- Do not freeze again food that has been thawed.
- Obey the storage instructions on the packaging of frozen food.

2.4 Internal light

- The type of lamp used for this appliance is not suitable for household room illumination.

2.5 Care and cleaning



WARNING!

Risk of injury or damage to the appliance.

- Before maintenance, deactivate the appliance and disconnect the mains plug from the mains socket.
- This appliance contains hydrocarbons in the cooling unit. Only a qualified person must do the maintenance and the recharging of the unit.
- Regularly examine the drain of the appliance and if necessary, clean it. If the drain is blocked, defrosted water collects in the bottom of the appliance.

2.6 Disposal



WARNING!

Risk of injury or suffocation.

- Disconnect the appliance from the mains supply.
- Cut off the mains cable and discard it.
- Remove the door to prevent children and pets to be closed inside of the appliance.
- The refrigerant circuit and the insulation materials of this appliance are ozone-friendly.
- The insulation foam contains flammable gas. Contact your municipal authority for information on how to discard the appliance correctly.
- Do not cause damage to the part of the cooling unit that is near the heat exchanger.

SINGLE DOOR REFRIGERATOR FEATURES

ERB5007

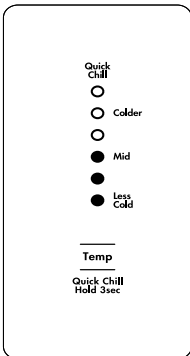
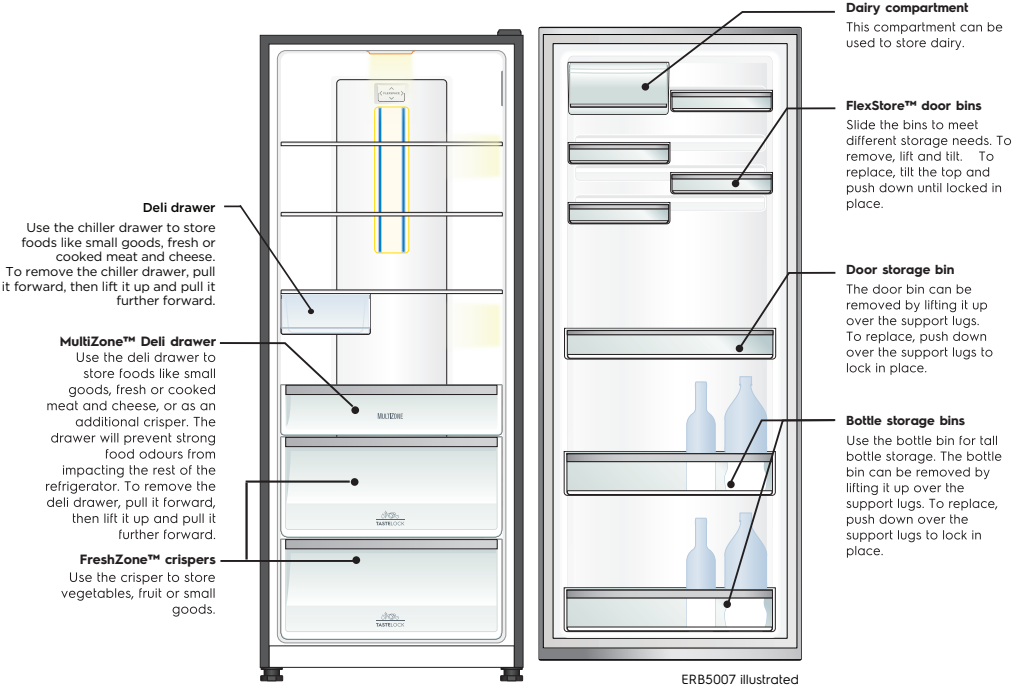

Refrigerator control panel

From this panel you can control the temperature of the refrigerator compartment as well as setting the quick chill function or resetting the door alarm.

For further information on how to use this feature refer to the section "About the User Interface".

Features may vary depending on model. Not all models will have features listed.

SINGLE DOOR REFRIGERATOR FEATURES

ERB5004

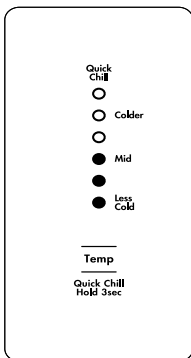
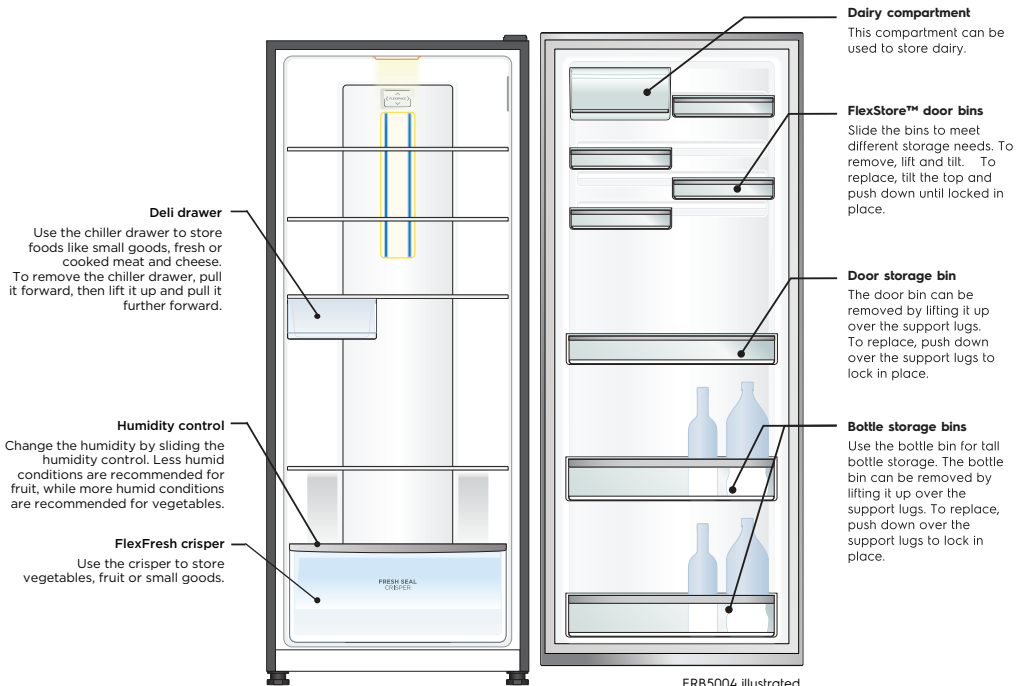

Refrigerator control panel

From this panel you can control the temperature of the refrigerator compartment as well as setting the quick chill function or resetting the door alarm.

For further information on how to use this feature refer to the section "About the User Interface".

Features may vary depending on model. Not all models will have features listed.

SINGLE DOOR FREEZER FEATURES

EFB5007 & EFB5004

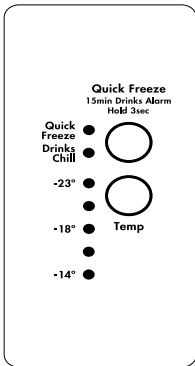
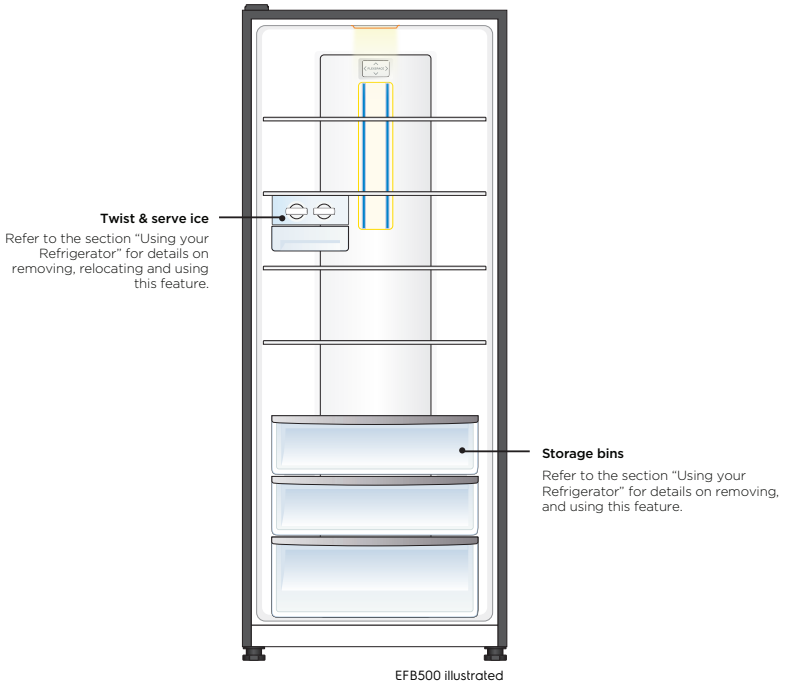

Freezer control

From this panel you can control the temperature of the freezer as well as setting the quick freeze and drinks chill functions or reset the door alarm.

For further information on how to use this feature refer to the section "Controlling your Refrigerator"

Features may vary depending on model. Not all models will have features listed.

ABOUT THE USER INTERFACE

Control - ERB5007/ERB5004 Models

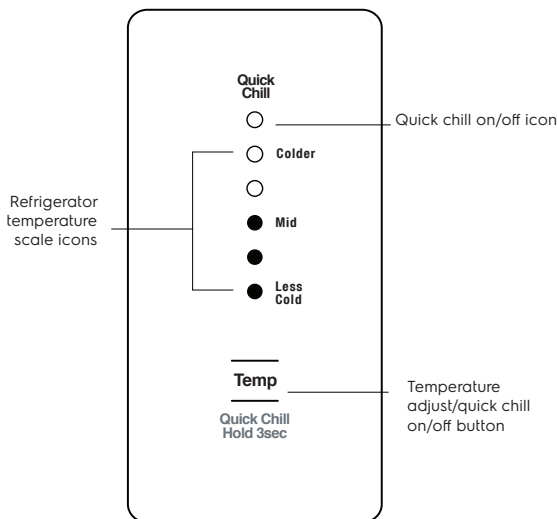

DESCRIPTION	OPERATION / PRIMARY FUNCTION
Refrigerator temperature scale icons	<ul style="list-style-type: none"> Indicates the temperature setting of the refrigerator compartment.
Quick Chill On/ Off icon	<ul style="list-style-type: none"> Indicates the status of the Quick Chill function.
Temperature adjust/ quick chill on/ off button	<p>Temperature Control</p> <ul style="list-style-type: none"> Touch the 'Temp' button to awaken control. Touch the 'Temp' button to decrease the refrigerator temperature. Once the coldest temperature is reached the display will return to the warmest setting with the next press. <p>Quick Chill</p> <ul style="list-style-type: none"> Use the quick chill function when you add a large amount of food to the refrigerator compartment. Press and hold the 'Temp' button for 3 seconds. The Quick Chill icon will flash indicating that the Quick Chill is active. Your refrigerator will run at 2°C for 90 minutes, then automatically return to normal mode. The Quick Chill function can be cancelled anytime by pressing the 'Temp' button again.



IMPORTANT

The factory default settings for the refrigerator is "Mid". If you want to change the temperature, remember to make only small adjustments and wait 24 hours to see if it's correct.

ABOUT THE USER INTERFACE

Control - EFB5007 / EFB5004 Models

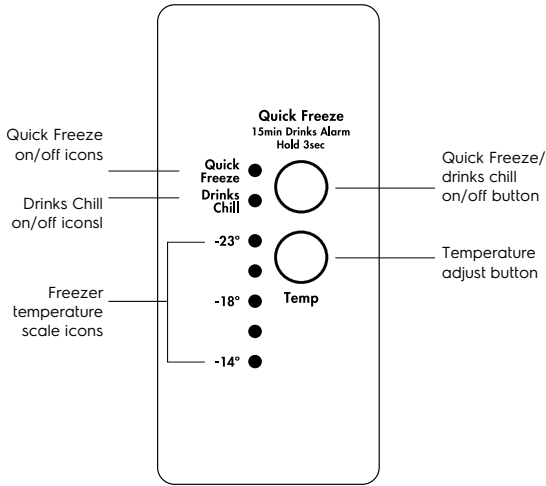

DESCRIPTION	OPERATION / PRIMARY FUNCTION
Quick Freeze on/ off icon	<ul style="list-style-type: none"> Indicates the status of the Quick Freeze function.
Drinks Chill on/ off icon	<ul style="list-style-type: none"> Indicates the status of the Drinks Chill function.
Quick Freeze/Drinks Chill button	<p>Use the Quick Freeze function when you add a large amount of food to the freezer compartment;</p> <ul style="list-style-type: none"> Press the 'Quick Freeze/Drinks Chill' button. The Quick Freeze icon will flash indicating that the quick freeze is active, and the compressor will run continuously for 24 hours. After 24 hours perform a defrost then the compressor will run continuously for 27 hours after finish will automatically return to normal mode. The Quick Freeze function can be cancelled anytime by pressing the button again. Use the "Drinks Chill" function when you need to chill drinks in the freezer compartment; Press and hold the 'Quick Freeze'/Drinks Chill button for 3 seconds. The Drinks Chill icon will activate indicating that the Drinks Chill is active. An alarm will sound and LED will flash after 15 mins. Drinks Chill can be cancelled at anytime by pressing Drinks Chill again for 3 seconds. The time taken to chill depends on the size of your bottle. Do not leave the bottle inside the freezer longer than the time needed for chilling.
Freezer temperature scale icons	<ul style="list-style-type: none"> Indicates the temperature setting of the freezer compartment
Temperature adjust button	<ul style="list-style-type: none"> Press any button to awaken control. Press the 'Temp' button to decrease the selected compartment temperature. Once the coldest temperature is reached the display will return to the warmest setting with the next press.



IMPORTANT

The factory default settings for the refrigerator is "3°C" and "-18°C" for the freezer. If you want to change the temperature, remember to make only small adjustments and wait 24 hours to see if it's correct.

INSTALLING YOUR NEW REFRIGERATOR

Unpacking



Most of the packing materials are recyclable. Please dispose of those materials through your local recycling depot or by placing them in appropriate collection containers.

Important – check for any damages or marks. If you find the refrigerator is damaged or marked, you must report it within 7 days should you wish to claim for damage/ marks under the manufacturers warranty. This does not affect your statutory rights.

Clean your refrigerator thoroughly following the instructions in the “Cleaning” section and wipe off any dust that has accumulated during shipping.

Locating the refrigerator



Automatic aerosol systems (such as insect control) should not be located adjacent to the product as the spray may cause long term damage to the external plastics of the appliance.

Do not put the refrigerator in a location that is too cold or is unprotected, for example in a garage or on a veranda. The ambient temperature should be above 10°C.

Put the refrigerator in a dry place avoiding areas of high moisture or humidity.

Ensure the refrigerator is located on an even surface.

Adequate ventilation around your refrigerator

The diagram below shows the recommended airspace to allow for ventilation of your refrigerator.

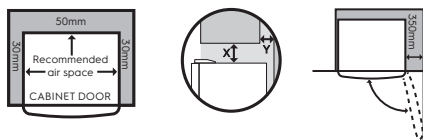

If you have a cupboard above the refrigerator with a rear gap of less than 100 mm (Y), recommended clearance at the top of the refrigerator increases from 50mm to 90mm (X) minimum.

When positioned in a corner area, spacing of at least 350mm (300mm for multi-door models) on the hinge side will allow the doors to open enough to enable the removal of bins and shelves.

NOTE: Doors are designed to sit proud of cabinetry (not flush). The clearances shown above are the recommended minimum clearances.

The clearance at the rear must not exceed 75mm.

Installing your refrigerator

1. Roll the refrigerator into place. The rollers are designed for forward or backward movement only. They are not castors. Moving the refrigerator sideways may damage your floor and the rollers. Before moving your refrigerator ensure height adjusting nut and the stability foot are fully wound up off the floor.
2. Wind the large height adjusting nut under door hinge down until the refrigerator is tilted back by 10mm (see diagram).

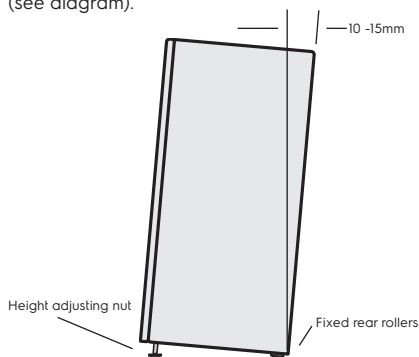

3. Wind the large height adjusting nut on the handle side down until the refrigerator is level and stable. If you have difficulty winding the nut or height adjusting foot down, have someone tilt the refrigerator back so you have better access.

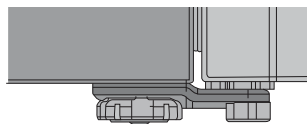

stability foot wound up

4. Check the alignment of the refrigerator to the surrounding cupboards to see if it is level. You can adjust the level as detailed in step 2 and 3.

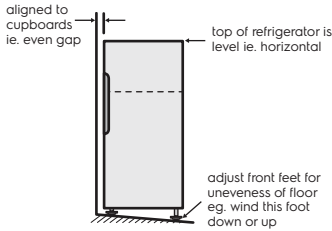

5. If you find your refrigerator rocks from corner to corner, it means your floor is uneven. Find a piece of plastic or hardboard etc. and pack it firmly under the roller.
6. You may now need to fine-tune the installation by repeating steps 3, 4 and 5.
7. When you have the appliance in its final position, it needs to be stabilised. Wind the stability foot under the door hinge down to the floor until it just makes contact with the floor. Lift the front of the appliance to take the weight off the stability foot, then turn it half a turn further to ensure firm contact with the floor. Wind the large height adjusting nut back up to ensure all the weight is now on the front stability foot.
8. Repeat step 7 for the stability foot on the handle side. Whenever you need to move the appliance, be sure to wind the feet back up so that the appliance can roll freely and be sure to reset it when reinstalling.

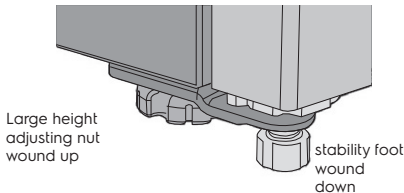

9. Plug your refrigerator straight into its own power point and never use a double adapter. If you need to roll the refrigerator to get to the plug, remember to raise the stability foot first.
10. Before you put any food in your refrigerator, it's recommended you leave it on for 2 or 3 hours to check it is running properly.

Fitting the handles

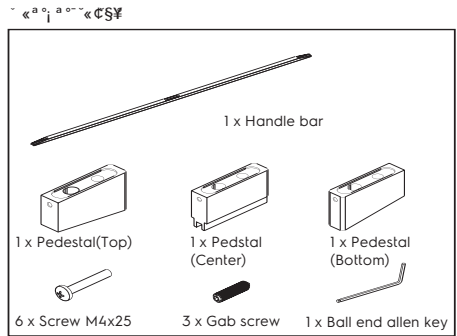

GENERAL WARNINGS

Please read the handle installation manual carefully and store in a handy place for later reference. Pass the handle installation manual on to possible new owners of the appliance. Read the following carefully to avoid damage or injury.

NOTE: You must read these warnings carefully before installing or using the accessory. If you need assistance, contact your Customer Care Department. The manufacturer will not accept liability, should these instructions or any other safety instructions incorporated in this book be ignored.



ENVIRONMENT

Remove and discard any packaging material before using this accessory. Most of the packaging materials are recyclable. Please dispose of those materials through your local recycling depot or by placing them in the appropriate collection containers.



WARNING

Risk of suffocation, injury or permanent disability.

- This accessory is not intended for use by persons (including children) with reduced physical, sensory or mental capabilities, or lack of experience and knowledge, unless they have been given supervision or instructions concerning the use of the appliance by a person responsible for their safety.
- This accessory may contain small parts that are a choking hazard. Not suitable for children 3 years of age.



CAUTION

⚠️ **CAUTION**
 This accessory is intended for domestic use only. Electrolux will not accept any liability for possible damage caused by improper or incorrect use.

- This accessory is for indoor use only.
- This accessory is intended for domestic use only. Electrolux will not accept any liability for possible damage caused by improper or incorrect use.
- When cleaning, use only a soft cloth with an unscented mild soap and lukewarm water.
- Never use hot water, solvents, commercial kitchen cleaners, aerosol cleaners, metal polishes, caustic or abrasive cleaners, or scourers to clean the accessory as they may damage it. Many commercially available cleaning products and detergents contain solvents that will damage your accessory.

LOCATE HANDLE BAR AND HANDLE KIT

- The bar handle is securely packed in the rear left hand EPS corner post packing.

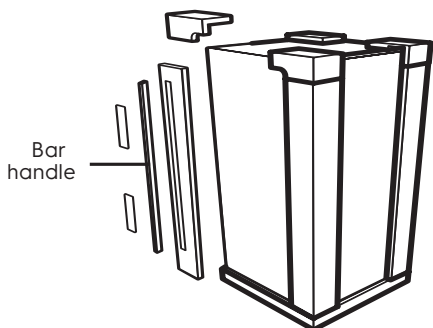
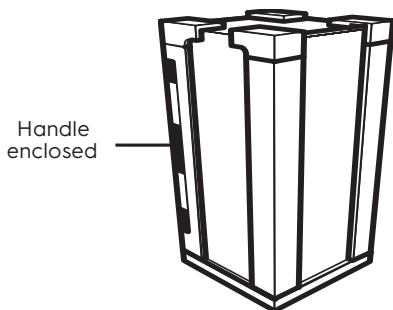

- The handle kit is located in the bottom of your refrigerator crisper or freezer drawer.

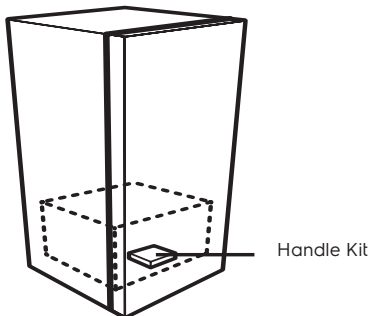

INSTALLATION

Bar handle assembly

- Using a suitable work space, place handle bar with screw holes facing up on a soft surface to prevent damage to handle.
- Locate and position the three handle pedestals on handle bar so that pins locate in holes and screw holes align. Note that the pedestals are identified top, bottom and center to aid assembly.
- Using Allen key, assemble the handle brackets to handle bar using the M4 screws provided.
- Ensure all screw are tight.

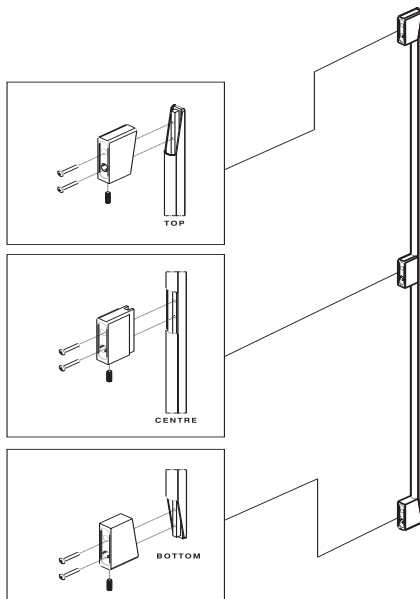

INSTALLATION

Assemble bar handle to door

Position the handle over handle mounts.

Step 1.

Tighten the set screw on the top pedestal in clockwise direction to secure the handle onto the door.

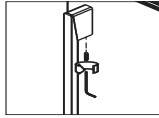

Step 2.

Tighten the set screw on the middle pedestal in clockwise direction to secure the handle onto the door.

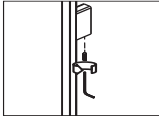

Step 3.

Tighten the set screw on the bottom pedestal in clockwise direction to secure the handle onto the door.

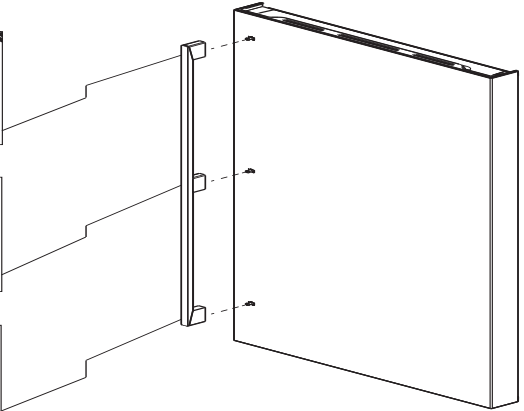
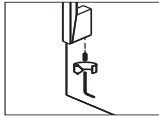

REMOVING PROTECTIVE FILM



WARNING

To protect your fridge door it is **ESSENTIAL** that the factory fitted protective film around the handle mounting points is not removed until after the handles are installed.

Step 1.

Place and position handle on door.

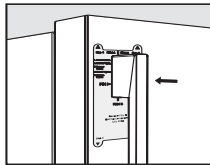

Step 2.

Secure the handle in place, by **LIGHTLY** tightening the screw using the **LONG END** of the provided Allen key. Please take care not to scratch the surface of the door with the end of Allen key.

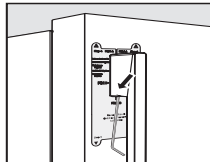

Step 3.

Gently remove upper protective film A.

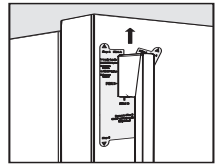

Step 4.

Lock the handle in place by **FIRMLY** tightening the screw using the **SHORT END** of the provided Allen key.

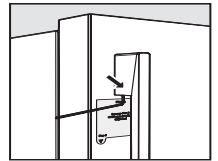

Step 5.

Gently remove lower protective film B. Repeat step 1-5 for all remaining handles.

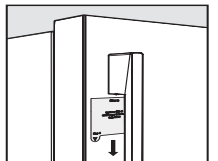

USING YOUR REFRIGERATOR

Refrigerators work by transferring heat from the food inside to the outside air. This operation makes the back and sides of the refrigerator feel warm or even hot particularly at start-up and on warm days - this is normal.

Avoid placing food against the air vents in the refrigerator as it affects efficient circulation. If the door is opened frequently, a light frosting will occasionally occur on the freezer's interior. This is normal and will clear after a few days. If the freezer door is accidentally kept open, a heavy frost will coat the inside walls and should be removed.

Your new refrigerator uses a high-speed compressor, along with other energy-efficient components, which may make unusual sounds and be more noticeable at night and quieter times. These sounds simply indicate your refrigerator is working how it should. They include:

- Compressor running noises;
- Air movement noise from the small fan motor;
- A gurgling sound, similar to water boiling;
- A popping noise, heard during automatic defrosting; and
- A clicking noise, prior to compressor start-up. Further details can be found in the Troubleshooting Guide.

REMOVING FEATURES

Removal of Crisper Drawer:

1. Empty food from the crisper. On some models it will be necessary to remove the bottle storage bins.
2. Remove the crisper by pulling forward, then up and forward again.
3. For top mount models, remove the crisper shelf by lifting the catches on the left and right underside of the shelf and pulling the shelf forward.

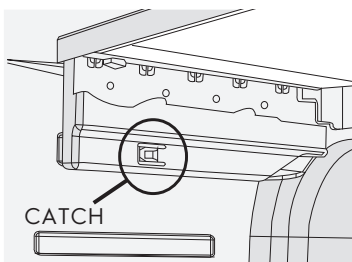

NutriPlus™ (Anti-Oxidant Filter)

Installing Filter Cartridge

Your filter can be found in the crisper. To enjoy the full benefit of NutriPlus™, it is important to install it after turning on the refrigerator. For installation, please follow the following instruction.

1. Remove plastic wrap
2. Hook the filter to the back of the crisper bin.

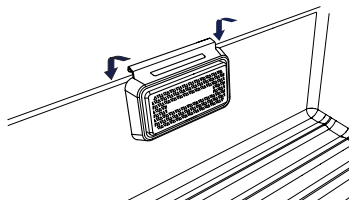

Replacing Filter Cartridge

The filter is located at the back of the crisper. Hold the filter, move upwards to release from the hooks.

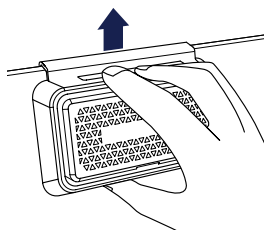

Glass shelves

To remove the shelves, gently pull them forward until the shelf comes clear of the shelf guides. To return the shelf, make sure there is nothing behind that may obstruct movement. Gently push the shelf, into the cabinet and back into position.

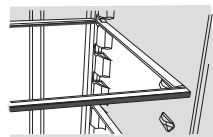

Freezer shelf

Remove the freezer shelf by lifting the catches on the right and left underside of the shelf to release the shelf then pull the shelf toward you.

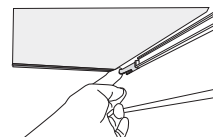

Drawers fitted with telescopic slides

To remove the drawer for cleaning.

1. Empty food from the drawer.
2. Remove the drawer by pulling it forward and lifting the front to unhook it from the slides. Once you have removed the drawer, ensure the slides are pushed back so they are fully closed.

WARNING

Never close the door while the telescopic slides are extended. This may damage the slide and/or refrigerator or cause the slide to become disengaged from the refrigerator.

To replace the drawer:

1. Ensure the telescopic slides are pushed in all the way.
2. Slide the drawer into place over the slides and push the bin in until it stops.
3. Drop drawer into position.

CAUTION

Never close the door while the telescopic slides are extended. It may damage the slide and/or the refrigerator or cause the slide to become disengaged from the refrigerator.

Twist and Serve Ice

Mounting the twist & serve dispenser to the other side of the freezer.

Note : This is only possible on top mount models.

1. Remove the ice bin and ice cube tray. If the ice tray assembly is frozen to the carriage, simply squeeze the tray and shelf together to break the ice.

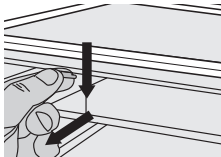

2. Before you remove the ice carriage, remember to disengage it from the glass shelf as it may result in damage to the assembly.
3. Remove the centre runner by disengaging it at the front of the shelf, and removing it from the rear.

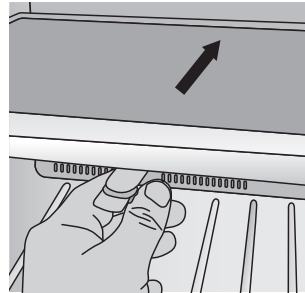

Insert Into the slot at the rear of the shelf

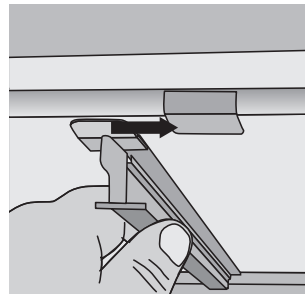

Then engage Into the front of the shelf

4. Refit the runner into the rear of the shelf on the right hand side and then engage the front.
5. Fit the carriage by sliding it into the runners until the front of the carriage engages with the shelf.
6. Refit the ice tray and ice bin.

WARNING

Fill the ice tube tray with potable water only.

CAUTION

LED lighting

Your appliance is fitted with long life LED lighting. In the unlikely event the LED lights should fail, then the LED lights should be serviced by the manufacturer.

Refer to the warranty page for contact details.

CLEANING YOUR REFRIGERATOR



WARNING

BEFORE CLEANING: Turn the refrigerator off at the power point and unplug the cord to prevent any chance of electrocuting yourself.

Doors and exterior (white and silver):

You should only clean the doors with lukewarm soapy water and a soft cloth.

Stainless Steel:

Your stainless steel refrigerator is manufactured from mark-resistant stainless steel. This stainless steel has a special advanced protective coating that eases the removal of marks such as fingerprints and water spots. To keep its appearance, clean it regularly with lukewarm soapy water and a soft cloth.



CAUTION

Never use stainless steel cleaners, abrasive pads or other cleaners that will scratch the surface. Damage to the appliance after delivery is not covered by your warranty.

Interior

Clean the inside of your refrigerator regularly with a soft cloth, unscented mild soap and lukewarm water. Thoroughly dry all surfaces and removable parts and avoid getting water on the controls. Replace removable parts, plug power cord in and switch the power on before returning the food.

Door seals

Always keep door seals clean by washing them with a mild detergent and warm water, followed by a thorough drying.

Sticky food and drink can cause seals to stick to the cabinet and tear when you open the door.



CAUTION

Never use hot water, solvents, commercial kitchen cleaners, aerosol cleaners, metal polishes, caustic or abrasive cleaners, or scourers to clean your refrigerator. Many commercially available cleaning products and detergents contain solvents that will damage your refrigerator. Use only a soft cloth with an unscented mild soap and lukewarm water.

To clean a crisper or freezer bin with telescopic extension slides, simply wipe with a damp cloth and warm soapy water. Never immerse the cover in water, as this could affect the operation of the slide.

Switching off your refrigerator

If you switch off your refrigerator for an extended period, follow these steps to reduce the chances of mould:

1. Remove all food.
2. Remove the power plug from the power point.
3. Thoroughly clean and dry the Interior.
4. Ensure that all the doors are wedged open slightly for air circulation.

FOOD STORAGE GUIDE

CATEGORY	PRODUCT	REFRIGERATOR	FREEZER	STORAGE TIPS
MEAT	Sausages and Mince	1-2 Days	2-3 Months	Keep cold meat at the back of the refrigerator where it is coldest.
	Chops and Steak	3-4 Days	4-6 Months	
	Cold Meats	3-5 Days	4-6 Months	Plastic can cause meat to sweat if stored in refrigerator for more than a day.
	Roasts	3-5 Days	12 Months	Roast can take up to 48 hours to defrost properly, transfer frozen roast to the refrigerator 2 days before use.
POULTRY	Chicken	1-2 Days	2 Months	If poultry takes on a smell or colour you are unsure about it is best to throw it out. Whole eggs are not suitable for freezing, slightly beaten eggs may be frozen for four months.
	Roast Chicken	3-5 Days	12 Months	
	Eggs	6 Weeks	Not Suitable	
SEAFOOD	Whole fish and fillets	2-3 Days	2 Months	Store in an air tight container or foil.
	Lobster and crabs	1-2 Days	2 Months	
	Prawns	1-2 Days	2 Months	Never freeze prawns in salty water as this will dehydrate the flesh.
DAIRY	Milk	Until Expiry Date	Not Suitable	If dairy takes on a smell or colour and you are unsure about it, it is best to throw it out.
	Yoghurt	7- 10 Days	Not Suitable	
	Hard Cheeses	2 Weeks – 2 Months	2 Months (Grated)	
	Soft Cheeses	1-2 Weeks	Not Suitable	Depending on the variety hard cheese can last from 2 weeks to 2 months.
	Butter	8 Weeks	12 Months	
FRUIT & VEGETABLES	Every fruit and vegetable has a different shelf life. Some stay fresh for a couple of days e.g beans, others can last for a couple of months e.g. onions.		8-12 Months When freezing chop and blanch in small portions.	Keep vegetables in the crisper and away from the air vents to avoid freezing. Don't wash fruit and vegetables before storing them in the refrigerator as this can make them susceptible to rotting.
	LEFT OVERS	Homemade meals	3-4 Days	2-6 Months

IMPORTANT

Please note, use this information as a guide only, actual storage times will vary depending on how you use your refrigerator, climatic conditions and the freshness of the food.

TROUBLESHOOTING

Appliance does not operate at desired temperature

In a modern frost free refrigerator / freezer, cold air is circulated around the various compartments through air vents using a high efficiency fan.

CONCERN	WHAT TO DO
Refrigerator is too warm	Ensure food is allowed to cool before placing inside the refrigerator.
	Ensure the appliance is set up as per instructions on page 11.
	Ensure that contents are not obstructing the cooling vents.
	Ensure the door is not held open or is being opened too frequently.
Freezer is too warm	Adjust temperature to a colder setting.
	Ensure food is allowed to cool before placing inside the freezer.
	Ensure the appliance is set up as per instructions on page 11.
	Ensure that contents are not obstructing the cooling vents.
Food is freezing in the refrigerator	Ensure the door is not held open or is being opened too frequently.
	Adjust temperature to a warmer setting.
Unable to change temperature settings	Ensure that fruit and vegetables are stored in the crisper. Items with a high water content should not be placed near the cooling vents.
	Refer to function guide in Controlling Your Refrigerator.
	Ensure that user interface is in "awake" mode before trying to adjust temperature settings.

Appliance noise

Your new refrigerator may make sounds that your old one didn't make. Because the sounds are new to you, you might be concerned about them. Most of the new sounds are normal. Hard surfaces, like the floor, walls and cabinets, can make the sounds seem louder than they actually are. The following describes the kinds of sounds and what may be making them.

CONCERN	WHAT TO DO
Motor noise (compressor)	Nothing. This is normal as your new refrigerator uses a high-speed compressor which switches on and off during operation.
	Note that the compressor noise may seem louder at the start of the on cycle.
A clicking noise heard just before the compressor starts.	Nothing. This is normal as your new refrigerator has an automatic switching action of the temperature control, turning the compressor on and off.
Occasional gurgling, similar to water boiling.	Nothing. As each cycle ends, you may hear a gurgling sound due to the refrigerant flowing in your refrigerator system.
Airflow noise.	Nothing, this is normal as your new refrigerator uses high efficiency fans to circulate air.
Rattling and other noises.	Ensure that the cabinet is level and stable, refer to Installation Instructions on page 6.
	Check the surrounds of the appliance to ensure there is nothing touching or placed on top of the appliance.
	Ensure that contents of the appliance are not placed in such a way that they are vibrating (such as bottles).

Crisper Operation

CONCERN	WHAT TO DO
Excess moisture build up in crisper It is normal for there to be some moisture and humidity in the crisper bin.	Ensure that the crisper is not over packed.
Crisper bin can not be removed	If crisper bin interferes with the door bins, remove door bins before removing crisper. Position cabinet so that the door can be fully opened.
Freezing items in the crisper	Adjust temperature to a warmer setting.

Refrigerator operation

CONCERN	WHAT TO DO
Appliance will not run	Ensure that the cord is plugged into a live power outlet and outlet is switched on.
It is normal for the freezer fan not to operate during the automatic defrost cycle, or for a short time after the appliance is switched on.	Ensure that the household circuit breaker has not tripped or that the fuse has not blown.
Compressor motor seems to run too long	The appliance maybe in defrost mode, check again in half an hour.
At normal room temperatures, expect your motor to run about 40% to 80% of the time. Under warmer conditions, expect it to run even more often.	Ensure that the doors are not held open
	Check that large amounts of warm food have not just been placed inside the appliance.
	Note that the appliance will run more than normal just after you install it or when adjusting to temperature setting changes.
The exterior of the appliance is warm or hot to touch	Ensure the appliance has the external clearances recommended in the section "Installing your new appliance".
This is normal because the appliance transfers heat from the inside out through the outer panels and the divider between the doors.	The exterior of the cabinet will be much warmer on warmer days it may even feel hot to touch, as the appliance is working harder.
User interface will not respond	Check that the user interface is in awake mode, refer to section "About the user interface".
To ensure settings are not accidentally changed the user interface will go into sleep mode when not in use. Press any button to wake user interface	Check that the user interface is not locked, refer to section "About the user interface".
	If the user interface is frozen turn the appliance off for five minutes for the memory to clear, then turn back on.
	Check that the user interface is not in Sabbath Mode, refer to control instructions. (I&W models only).
Alarms Sounding	Check that all doors are fully closed.
	Ensure that the over temperature alarm is not being activated by hot food placed in the freezer.
	Check if the drinks timer has ended, refer control instructions.
	Check if the Filter Replacement alert is activated, refer control instructions. (I&W models only)
Frost build up	Check that all doors are fully closed.
	Ensure that the doors are not opened too often.
	Ensure that the return air vents are not blocked with packaging.
	Ensure the seals are clean and not obstructed.
Odours	The interior may need cleaning, refer to cleaning guide.
	Ensure that food is stored correctly as some food, containers and wrapping can produce odours.
	Check appliance for old or unusual food.
Lights not working	Ensure that the cord is plugged into a live power outlet and outlet is switched on.
The LED lighting is designed to dim automatically if the door is left opened for more than 5 minutes and turn off completely if the door is open for more than 7 minutes. Closing the door will reset the timer.	Ensure that the household circuit breaker has not tripped or that the fuse has not blown.
The LED lighting is also designed to turn on gradually.	Check that the user interface is not in Sabbath Mode, refer to control instructions.
	Check the appliance features section to determine lighting configuration for your model. Check that the doors are closed completely

TROUBLESHOOTING

Door operation

CONCERN	WHAT TO DO
Freezer door pops open.	<p>This is normal and should re-close. This happens when the refrigerator door is closed too quickly.</p> <p>If the freezer door stays open, it indicates that the appliance needs to be tilted backwards a little further. Refer to section "Installing your new appliance".</p>
Self close not working.	<p>Check if your appliance has self closing hinges as not all models do.</p> <p>It indicates that the appliance needs to be tilted backwards a little further. Refer to section "Installing your new appliance".</p>
Door not sealing properly	<p>Ensure there is nothing that is preventing the door from closing such as appliance contents or items placed near the appliance.</p> <p>Ensure that the crisper/freezer bin is closed completely. Refit if required as referred to in the section "Using your refrigerator".</p> <p>Ensure the appliance is set up as per recommendations.</p>
Door difficult to open and close	<p>If the door is difficult to open just after you have closed it this is due to the pressure equalising, the door will open normally after a few minutes.</p>

If you still require service

If you have a problem, and the problem persists after you have made the checks mentioned, contact your nearest Electrolux approved Service Centre or the dealer you bought the refrigerator from. Be ready to quote the model number, the 9-digit PNC and 8-digit serial number, which is stated on the label inside the refrigerator compartment.

NOISES

There are some sounds during normal running (compressor, refrigerant circulation).

